

cps[®] VOLT-100 WIRELESS CLAMP POWER METER



cps[®] link™

US Patent No. 9,043,161



Intertek



OWNER'S MANUAL (English)

www.cpsproducts.com

FOR USE BY QUALIFIED PERSONNEL

CONTENTS

1. Safety information	4
1.1 Preparation	4
1.2 Use	5
1.3 Symbols	6
1.4 Maintenance	7
2. Description	8
2.1 Component layout	8
2.2 Descriptions of switches, keys, input jacks	10
2.3 LCD display	11
2.4 LCD symbols	12
3. Specifications	13
3.1 General specifications	13
3.2 Technical specifications	14
3.2.1 Alternating current	15
3.2.2 Inrush current	15
3.2.3 DC voltage	15
3.2.4 AC voltage	16
3.2.5 Frequency	16
3.2.6 Duty ratio	17
3.2.7. Resistance	18
3.2.8 Circuit continuity test	18
3.2.9. Capacitance	18
3.2.10 Diode test	19
3.2.11 Single-phase active power	19
3.2.12 Single-phase apparent power	19
3.2.13 Single-phase reactive power	20
3.2.14 Power factor	20
3.2.15 Harmonics measurement	20
4 Operation Guide	21
4.1 Reading holding	21
4.2 Manual range	21
4.3 Switchover of frequency and duty ratio	21

CONTENTS

4.4 Selection of maximum/minimum value measurement	21
4.5 Function switching	22
4.6 Measurement of relative value	22
4.7 Wireless operation (CPS Link)	23
4.8 Data logging function	24
4.9 ▼ Function	25
4.10 ▲ Function	25
4.11 Cost of operation	25
4.12 INRUSH measurement	26
4.13 Back-light and clamp lighting	26
4.14 Automatic shutdown	27
4.15. Measurement preparation	27
4.16 AC current measurement	27
4.17. Voltage measurement	29
4.18 Measuring frequency and duty ratio	30
4.19 Resistance measurement	33
4.20 Diode test	34
4.21 Circuit continuity test	35
4.22 Capacitance measurement	37
4.23 Measurement of inrush current	38
4.24 NCV measurement	39
4.25 Active power measurement	40
4.26 Apparent power measurement	42
4.27 Power factor measurement	44
4.28 Phase angle measurement	46
4.29 Harmonics measurement (voltage signal)	47
4.30 Harmonics measurement (current signal)	49
5 Maintenance	51
5.1 Battery replacement	51
5.2 Probe replacement	51
5.3 Calibration	52
6 Accessories	53

1. SAFETY INFORMATION

WARNING

PLEASE PAY SPECIAL ATTENTION WHEN USING THIS METER, AS IMPROPER USE MAY RESULT IN ELECTRIC SHOCK OR DAMAGE TO THE METER. PLEASE FOLLOW THE COMMON SAFETY RULES, AND FULLY COMPLY WITH THE SAFETY PRECAUTIONS SPECIFIED IN THE USER MANUAL.

TO MAKE FULL USE OF THE METER, AND ENSURE SAFE OPERATION, PLEASE READ CAREFULLY AND FOLLOW THE APPLICATION METHODS IN THIS SPECIFICATION.

This meter conforms to GB/T 13978-92: Generic Specification for Digital Multi-meters, GB4793.1-1995 (IEC-61010-1, IEC-61010-2-032): Safety Requirements of Electronic Measuring Instrument. It causes secondary pollution, and the over-voltage standard is CAT IV 600 V and CAT III 1,000 V. Please abide by the safe operation guidance to ensure the safe use of the meter. Appropriate use and protection of the meter will provide satisfactory service.

1.1 PREPARATION

- 1.1.1 Users must comply with the following safety regulations when using this meter:
 - General electric shock protection
 - Prevent misuse of the meter
- 1.1.2 After receiving this meter, check whether it was damaged in transportation.
- 1.1.3 Check whether the meter was damaged after being stored.
- 1.1.4 The probe must be in good condition. Before using, check whether the insulation of the probe is broken and the metal wire of the conductor is exposed.
- 1.1.5 If required, the probe provided with this meter must be replaced with a probe of the same grade.











1. SAFETY INFORMATION

1.2 USE

- 1.2.1 Use this meter according to requirements of correct functions and measuring range.
- 1.2.2 **DO NOT** exceed the indicated value of protection of each measuring range during measurement.
- 1.2.3 **DO NOT** touch the top of the probe when the meter is connected for measuring circuits.
- 1.2.4 During measurement, if the measured voltage is higher than 60V DC or 30 V AC (effective value), keep fingers behind the probe protector at all times.
- 1.2.5 **DO NOT** measure voltage when AC voltage between the measuring terminal and ground is greater than 750 V.
- 1.2.6 Select the highest range of the manual range if you don't know the measured value in advance.
- 1.2.7 Remove probes from the measured circuit before rotating the change-over switch to change the measuring function.
- 1.2.8 **DO NOT** perform live line measurement for resistance, capacitance, diodes and circuit continuity.
- 1.2.9 **DO NOT** connect meter to a voltage source during current, resistance, capacitance, diodes and circuit continuity test.
- 1.2.10 **DO NOT** measure capacitance before a capacitor is fully discharged.
- 1.2.11 **DO NOT** use this meter near explosive gas, steam or dust.
- 1.2.12 In case of any abnormality or fault, please stop using the meter.
- 1.2.13 **DO NOT** use this meter, unless the bottom case and the battery cover are fully fastened in place.
- 1.2.14 **DO NOT** store or use this meter in direct sunlight, high temperature, or high humidity.

1. SAFETY INFORMATION

1.3 SYMBOLS

	Note-Important safety information, refer to the instruction manual.
	Application around and removal from UNINSULATED HAZARDOUS LIVE conductors is permitted.
	Caution, possibility of electric shock
	Equipment protected throughout by double insulation or reinforced insulation.
	Conforms to UL STD. 61010-1, 61010-2-032, 61010-2-033; Certified to CSA STD C22.2 NO. 61010-1, 61010-2-032, 61010-2-033
	Complies with European (EU) safety standards
	Earth (ground) terminal
	Direct current
	Alternating current
	Both direct and alternating current
CAT III	It is applicable to test and measuring circuits connected to the distribution part of the building's low-voltage MAINS installation.

1. SAFETY INFORMATION

1.4 MAINTENANCE

- 1.4.1 **DO NOT** open the bottom case of this meter for adjustment or repair. This operation can only be performed by technicians who understand this meter and shock hazard.
- 1.4.2 Please remove the probe from a measured circuit before opening the bottom case or the battery cover of the meter.
- 1.4.3 In order to avoid electric shock caused by incorrect reading, when the meter displays "" replace the battery immediately.
- 1.4.4 Use wet cloth and mild detergent to clean the meter, and do not use abrasives or solvents.
- 1.4.5 To turn off meter when not in use, rotate the range switch to OFF.
- 1.4.6 If meter is not to be used for an extended time, remove battery.
- 1.4.7 Recalibrate under the conditions of 64°F ~ 82°F (18°C ~ 28°C) and relative humidity less than 75%, with calibration cycle of 1 year.

2. DESCRIPTION

The VOLT-100 is a portable, professional multifunction instrument with an LCD display for obtaining electrical measurements. It can be used as a conventional clamp meter or may be paired to Apple & Android smartphones & tablets via Bluetooth® for additional functionality.

Key Features:

- **Data Logging** - Of electrical readings (1 sample/sec., with maximum of 1000 samples or 16 mins, 40 secs.)
- **Power Factoring** - To determine true power consumption
- **Utility Data Feed** - Calculates actual cost/hour to operate appliances

Additional Features:

- Measures inrush and AC current AC/DC voltage, resistance, frequency, capacitance circuit connection, duty cycle, non-contact voltage and diode.
- Manual and automatic measuring range
- Min/max and clamp head frequency measurement
- Relative measuring
- Overload protection
- Reading hold
- Display backlight and auto off

2.1 COMPONENT LAYOUT

1. Current clamp head (for current measurement)
2. Clamp lamp
3. Faceplate
4. Trigger
5. Key for data storage and switch of auto and manual range
6. Key for maximum/minimum selection
7. Key for function switch
8. Key for reading holding/back-light
9. LCD display

2. DESCRIPTION

10. Input jack of resistance, capacitance, voltage, frequency, diode and continuity
11. Jack of common terminal
12. Key for frequency and duty ratio measurement, inrush current and up
13. Key for Bluetooth function, relative measurement and down
14. Change-over switch
15. NCV indicator light
16. Protective Barrier (limit of safe access)
17. Wire pick

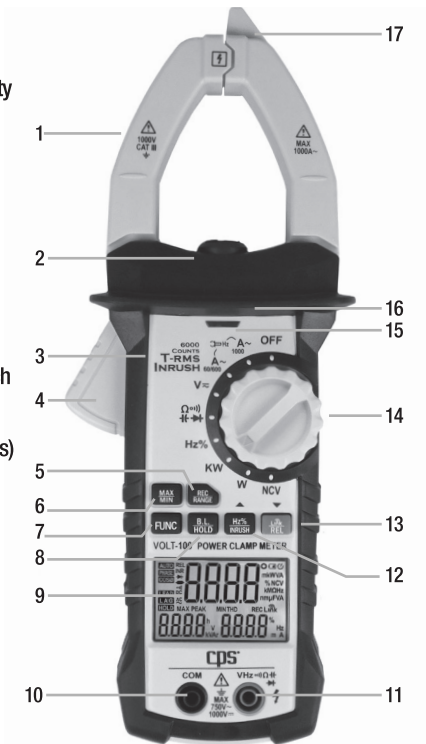

2. DESCRIPTION

2.2 DESCRIPTIONS OF SWITCHES, KEYS AND INPUT JACKS

FUNC Key: For switching the measurement function.

B.L/HOLD Key: Readings will be held by during a short press, and the back-light will be turned on by a long press. The back-light and clamp lamp will be turned on at the same time by pressing the **B.L/ HOLD** key in the current switch position and in the power position on the current interface.

REC/RANGE Key: Short press for switching between Auto and Manual range mode, and long press for Data Storage

LINK/REL/ Key

1. Long press for validating Bluetooth in all positions.
2. Short-press in the harmonic measurement interface at KW and W positions to scroll down, and to switch between the 1st harmonic and 20th harmonic. At the KW and W positions, short-press the Function Key in the maximum/minimum value measurement interface to scroll down, and switch and display the maximum/minimum value.
3. Short press on Alternating Current, AC/DC voltage and capacitance for relative value measurement mode.

Hz%/INRUSH/ Key

1. Short press on Alternating Current, Alternating Voltage and HZ% positions to switch among alternating current or alternating voltage, frequency and duty ratio.
2. Short-press on the harmonic measurement interface at KW and W positions to scroll up, and switch between the 1st harmonic and 20th harmonic. At the KW and W positions, short-press the function key in the maximum/minimum value measurement interface to scroll up, and switch and display the maximum/minimum value.
3. Long press on the alternating current position for switching to the measurement mode of inrush current.

2. DESCRIPTION

MAX/MIN Key: To switch between maximum/minimum measurement.

OFF Position: To turn the meter OFF.

INPUT Jack: Input terminal of voltage, resistance, frequency, duty ratio, capacitance, diode and circuit continuity.

COM Jack: Common terminal of voltage, resistance, frequency, duty ratio, capacitance, diode and circuit continuity.

Change-Over Switch: For selection of functions and range



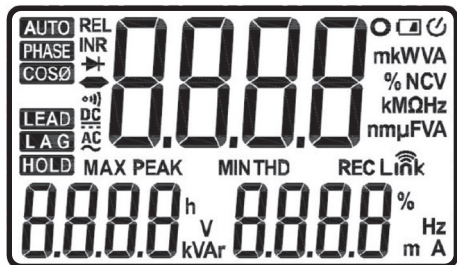

2.3 LCD DISPLAY



(All Segments Shown ON)

2. DESCRIPTION

2.4 LCD SYMBOLS

AC, DC	Alternating current / Direct current
	Diode and Continuity function
AUTO	Auto range mode
MAX /MIN	Status of Maximum/Minimum measurement
REL	Status of relative measurement
	Status of automatic shutdown
	LOW BATTERY
HOLD	Status of reading holding
HZ	Frequency measurement
%	Percentage (duty ratio)
mV, V	Millivolt, volt (voltage)
A	Ampere (electric current)
nF, μ F, mF	Nano farad, microfarad and millifarad
Ω , k Ω , M Ω	Ohm, kilo-ohm and megohm (resistance)
Hz, kHz, MHz	Hertz, kilohertz and megahertz (frequency)
NCV	Non-contact voltage detection
W, KW	Watt and kilowatt (active power)
VA, KVA	Unit of apparent power
Var, KVAr	Reactive power
ϕ	Phase angle
PEAK	Peak value measurement
THD	Total harmonic distortion
H01F	Total harmonic distortion F (relative to fundamental wave)
H01r	Total harmonic distortion r (relative to actual effective value)
COS Φ	Power factor
Phase	Phase
INR	Status of inrush current measurement
REC	Data recorder
	Bluetooth function
LEAD	Leading phase angle
LAG	Lagging phase angle
h	Hour (time unit)
	Negative sign

3. SPECIFICATIONS

3.1 GENERAL SPECIFICATIONS

- Auto range and manual range.
- Full-scale overload protection.
- Maximum allowable voltage between measured end and ground: 1,000 V DC or 750 V AC.
- Working height: less than 2,000 m.
- Display: LCD.
- Maximum displayed value: 5999 dgt.
- Polar indication: self-indicating, “-” means negative polarity.
- Over-range display: ‘OL’ or ‘-OL’.
- Sampling time: Approx. 3X/second .
- Unit display: display functions and units of electric quantity.
- Automatic shutdown: 30 minutes.
- Power supply: 9V DC.
- Battery Type: NEDA 1604 or 6F22.
- Under-voltage indication of battery: LCD display symbol.
- Temperature coefficient: less than $0.1 \times \text{degree of accuracy}/^{\circ}\text{C}$.
- Working temperature: $18^{\circ}\text{C} \sim 28^{\circ}\text{C}$.
- Storage temperature: $-10^{\circ}\text{C} \sim 50^{\circ}\text{C}$.
- Dimension: $9.4'' \times 3.6'' \times 2''$ ($238 \times 92 \times 50$ mm).
- Weight: around 0.9 lb (420 g) (including battery).

3. SPECIFICATIONS

3.2 TECHNICAL SPECIFICATIONS

Wattage	3W/100W/4000W/10kW/100kW/750kW (+/- 3.0%+5d reading)
Maximum Input Current	1000A AC
Maximum Input Voltage	750V AC (TRMS); 1000V DC
AC Volts	6V/60V/600V/750V 0~600V (+/-0.6%+4d reading); 750V (+/-0.8%+4d reading)
DC Volts	6V/60V/600V/1000V 0~600V (+/-0.5%+5d reading); 750V (+/-0.8%+4d reading)
AC Amps	60/600/1000A 0~1000A (+/-2.0%+8d reading)
OHMs	600/6K/60K/600K/6M/60M 0~600k ohm(+/- 0.8%+3d reading) 600k~60M ohm (+/- 2.0%+5d reading)
Capacitance	10nF/100nF/1µF/10µF/100µF/1mF/10mF/100mF (+/-3.0%+5d reading)
Frequency (Through Jaw Clamp)	99.99 Hz to 999.9 Hz
Frequency (Through Mode V)	99.99 Hz to 9.999 kHz
Frequency (Through Mode HZ/DUTY)	9.999 Hz to 9.999 MHz
Measuring Range Overload Protection	Yes (Full Range)
Sampling Rate Approx.	3 times/sec.
LCD Display Auto-Off	After 30 minutes (if no operation)
Test Leads (Red, Black)	39" (1 m), Included
Battery Undervoltage Indication	Display shows
Polarity Indication	Automatic ("-" = negative polarity)
Display Indication (Exceeds Max Range)	"OL" or "-OL"
Temperature Coefficient	<0.1 X accuracy/°C
Clamp, Max Opening	1.6" (42 mm)
Full measuring range overload protection	Yes
Battery	One 9V DC (Included)
Operation Temperature	32°F~104°F (0°C ~ 40°C)
Storage Temperature	-14°F~122°F (-10°C ~ 50°C)
Size (H x W x D)	9.4" x 1.9" x 3.6" (238 x 50 x 92 mm)
Weight (Including Battery)	0.92 lb (420 g)
Warranty	1 year

3. SPECIFICATIONS

Environmental temperature: $23\pm 5^{\circ}\text{C}$ relative humidity: $\leq 75\%$

3.2.1 ALTERNATING CURRENT

Measuring range	Resolution	Accuracy
60A	0.01A	$\pm(2.0\% \text{ reading} + 8 \text{ digits})$
600A	0.1A	
1000A	1A	

- Maximum input current: 1000A AC
- Frequency range: 40~400Hz

3.2.2 INRUSH CURRENT

Measuring range	Resolution	Accuracy
60A	0.01A	$< 60 \text{ A (for reference only)}$ $\pm (5\% \text{ reading} + 60 \text{ reading})$
600A	0.1A	
1000A	1A	

- Integral time: 100 ms
- measurement range: 20~1,000 A
- frequency range: 40~400 Hz

3.2.3 DC VOLTAGE

Measuring range	Resolution	Accuracy
600mV	0.1mV	$\pm(0.5\% \text{ reading} + 5 \text{ digits})$
6V	0.001V	
60V	0.01V	
600V	0.1V	
1000V	1V	$\pm(0.8\% \text{ reading} + 4 \text{ digits})$

- Input impedance: 10M
- Maximum input voltage: 750V AC (effective value) or 1000V DC

3. SPECIFICATIONS

3.2.4 AC VOLTAGE

Measuring range	Resolution	Accuracy
6V	0.001V	±(0.6% reading + 4 digits)
60V	0.01V	
600V	0.1V	
750V	1V	±(0.8% reading + 4 digits)

- Input impedance: 10M
- Maximum input voltage: 750V AC (effective value) or 1000V DC
- Frequency range: 40 - 400Hz

Note: Under the small voltage range, there might be a reading on the meter before the probe is connected to the measured circuit. This is normal because this meter has high sensitivity and it has no influence on the actual measurement result.

3.2.5 FREQUENCY

3.2.5.1 Frequency measurement with clamp (at A gear):

Measuring range	Resolution	Accuracy
99.99Hz	0.01Hz	±(1.5% reading + 5 digits)
999.9Hz	0.1Hz	

- Measurement range: 10Hz-1kHz
- Range of input signal: ≥ 20A AC (the input current is increased with the measured frequency)
- Maximal input current: AC 1000 A (effective value)

3.2.5.2 At V Position:

Measuring range	Resolution	Accuracy
99.99Hz	0.01Hz	±(1.5% reading + 5 digits)
999.9Hz	0.1Hz	
9.999Hz	0.001kHz	

- Measurement range: 10 Hz~10kHz
- Range of input voltage: ≥ 1 V AC (effective value) (the input voltage is increased with the measured frequency)
- Input impedance: 10MΩ
- Maximum input voltage: 750 V AC (effective value)

3. SPECIFICATIONS

3.2.5.3 At HZ/DUTY Position:

Measuring range	Resolution	Accuracy
9.999Hz	0.001Hz	±(0.3% reading + 5 digits)
99.99Hz	0.01Hz	
999.9Hz	0.1Hz	
9.999kHz	0.001kHz	
99.99kHz	0.01kHz	
999.9kHz	0.1kHz	
9.999MHz	0.001MHz	

- Overload protection: 1,000 V DC or 750 V AC (effective value)
- Range of input voltage: ≥ 2 V (the input voltage is increased with the increase of the measured frequency)

3.2.6 Duty Ratio

Measuring range	Resolution	Accuracy
0.1-99.9%	0.1%	± (3.0%+3)

3.2.6.1 At A Position (from the clamp):

- Frequency response: 10 ~ 1 kHz.
- Range of input current: ≥ 20 A AC (effective value)
- Maximal input current: AC 1,000 A

3.2.6.2 At V Position:

- Frequency response: 10 ~ 10kHz.
- Range of input voltage: 1 V AC.
- Input impedance: $10M\Omega$
- Maximum input voltage: 750 V AC (effective value)

3.2.6.3 At HZ/DUTY Position:

- Frequency response: 10 ~ 10MHz.
- Range of input voltage: ≥ 2 V AC (effective value) (the input voltage is increased with the measured frequency)
- Maximum input voltage: 250V AC (effective value)

3. SPECIFICATIONS

3.2.7 RESISTANCE

Measuring range	Resolution	Accuracy
600Ω	0.1Ω	±(0.8% reading + 3 digits)
6kΩ	0.001kΩ	
60kΩ	0.01kΩ	
600kΩ	0.1kΩ	
6MΩ	0.001MΩ	±(2.0% reading + 5 digits)
60MΩ	0.1MΩ	

- Open circuit voltage: about 0.78 V
- Overload protection: 1,000 V DC or AC (effective value)

3.2.8 CIRCUIT CONTINUITY TEST

Measuring range	Resolution	Function
600Ω •))	0.1Ω	If the resistance of measured circuit is less than 50Ω, the buzzer inside the meter will send a sound.

- Open-circuit voltage: around 1.48V
- Overload protection: 1,000 V DC or 750 V AC (effective value)

3.2.9 CAPACITANCE

Measuring range	Resolution	Accuracy
9.999nF	0.001nF	±(3.0% reading + 5 digits)
99.99nF	0.01nF	
999.9nF	0.1nF	
9.999μF	0.001μF	
99.99μF	0.01μF	
999.9μF	0.1μF	
9.999mF	0.001mF	
99.99mF	0.01mF	

- Overload protection: 1,000 V DC or 750 V AC (effective value)

3. SPECIFICATIONS

3.2.10 DIODE TEST

Measuring range	Resolution	Function
3V 	0.001V	Display the approximate value of diode forward voltage

- DC forward current is around 1 mA
- DC reverse voltage is around 3.2 V
- Overload protection: 1,000 V DC or 750 V AC (effective value)

3.2.11 SINGLE-PHASE ACTIVE POWER

Measuring range	Resolution	Function
3W	0.01W	±(3.0% reading + 5 digits)
100W	0.1W	
4000W	1W	
10kW	0.01kW	
100kW	0.1kW	
750kW	1kW	

- Minimum input current: 1 mA, and minimum input
- Voltage: 1 V

3.2.12 SINGLE-PHASE APPARENT POWER

Measuring range	Resolution	Function
3VA	0.01VA	±(3.0% reading + 5 digits)
100VA	0.1VA	
4000VA	1VA	
10kVA	0.01kVA	
100kVA	0.1kVA	
750kVA	1kVA	

- Minimum input current: 1 mA, and minimum input
- Voltage: 1 V

3. SPECIFICATIONS

3.2.13 SINGLE-PHASE REACTIVE POWER

Measuring range	Resolution	Function
3W	0.01W	±(3.0% reading + 5 digits)
100W	0.1W	
4000W	1W	
10kW	0.01kW	
100kW	0.1kW	
750kW	1kW	

- Minimum input current: 1 mA, and minimum input
- Voltage: 1 V

3.2.14 POWER FACTOR

Measuring range	Resolution	Function
0.3 ~ 1 capacitive	0.001	±(3.0% reading + 5 digits)
0.3 ~ 1 inductive	0.001	

- Minimum input current: 1 mA, and minimum input
- Voltage: 1 V

3.2.15 HARMONICS MEASUREMENT

Measuring range	Accuracy of harmonic electrical level
1	±(3.0% reading + 10 digits)
2-6	±(3.5% reading + 10 digits)
7-8	±(4.5% reading + 10 digits)
9-10	±(5.0% reading + 10 digits)
11-15	±(7.0% reading + 10 digits)
16-20	±(10.0% reading + 10 digits)

- Minimum input current: 1 mA, and minimum input
- Voltage: 1 V

4. OPERATING GUIDANCE

4.1 READING HOLD

1. During measurement, if the reading is to be held, short-press the “HOLD/B.L” key to lock the display value, and short-press the “HOLD/B.L” key to unlock the kept reading.

4.2 MANUAL RANGE

1. The **RANGE** key is used for setting the Auto/Manual range. This key can be activated through triggering. Its startup default state is auto range. Press the key once to switch to the manual range. In the manual range mode, move the meter to the next higher position after pressing the key once, and after moving to the highest position, press the key continuously to move the meter to the lowest position. Perform the cyclic operations in sequence. If the key is pressed for more than 2 seconds, the meter will be switched to Auto Range state.

Note: When measuring diode, continuity test, capacitance, and frequency KW, W and NCV gear, the manual range is unavailable.

4.3 SWITCHOVER OF FREQUENCY AND DUTY RATIO

1. When the meter is at AC current position, short-press the “Hz/%/INRUSH/” key for the meter to be in Hz measurement state to measure the frequency of measured AC voltage and current signals. Then, short-press the “Hz/%/INRUSH/” key again for the meter will be in DUTY measurement state to measure the duty ratio of measured voltage and current signals. If the meter is in HZ/% position, short press “Hz/%/INRUSH/” key to switch the meter to the HZ and DUTY states circularly.
2. If the meter is in AC current and AC/DC voltage position, short-press the “Hz/%/INRUSH/” key, the meter will be in the voltage and current measurement state.

4.4 SELECTION OF MAXIMUM/MINIMUM VALUE MEASUREMENT

1. Press the “MAX/MIN” key in the kW and W position. The interface will simultaneously display the maximum and minimum values obtained after the test for a period of time. Then press the or key on this interface to enter the interface above operations by recycling displaying the time of record. After that, the specific time period of these maximum and minimum values will be displayed.

4. OPERATING GUIDANCE

2. When the meter is at AC Current position, AC/DC voltage position and resistance position, press “MAX/MIN” to enter the MAX mode and measure the maximum value all the time. Press “MAX/MIN” key again to enter the state for measuring minimum value. Press the “MAX/MIN” key a third time to exit the measurement mode of maximum and minimum value.

Note:

a) *The meter is in manual range mode under the measurement states of max/min value.*

4.5 FUNCTION SWITCHING

1. Long-press the **FUNC** key in the power measurement interface to enter the power, voltage and current measurement interface.
2. Short-press the **FUNC** key in the power measurement interface to enter the active power, apparent power, reactive power, power factor and phase angle measurement interface.
3. When the meter is at power position, short-press the **FUNC** key in the voltage measurement interface to enter the voltage effective value, harmonic, harmonic distortion rate THD-R and harmonic distortion rate THD-F measurement interface.
4. When the meter is at power position, short-press the **FUNC** key in the current measurement interface to enter the current effective value, harmonic, harmonic distortion rate THD-R and harmonic distortion rate THD-F measurement interface.
5. When the meter is at DC/AC position, short-press the **FUNC** key to switch between the DC voltage measurement and AC voltage measurement interface.
6. When the meter is at resistance/diode/buzzer/capacitance position, shortpress the **FUNC** key to switch among resistance, diode, buzzer and capacitance measurement.

4.6 MEASUREMENT OF RELATIVE VALUE

1. Short-press the **LINK/REL/▼** key at AC current, AC/DC voltage and capacitance positions to enter the relative value measurement mode and store the current display value in memory as the reference value. For the sequent measurement, the displayed value is the difference between the input value

4. OPERATING GUIDANCE

and reference value, i.e. $REL\Delta$ (current reading) = input value - reference value.

- Relative value measurement is only available in the manual measurement mode.

4.7 WIRELESS OPERATION (CPS LINK)

At any setting (excluding OFF), long-press LINK/REL/▼ to turn ON the Bluetooth capability.

- Download and open the CPS Link™ app from Apple iTunes (iOS) or Google Play Store (Android).

- Make sure Bluetooth is activated on your smartphone or tablet, turn on the VOLT-100 by turning the selector switch and press the blue button that says **Link/REL**.

- Select the VOLT-100 icon on the app.

- After pairing the Volt-100 to your mobile device, the APP will show content displayed on the Volt-100 in real time. Long-press the **LINK/REL/▼** key once again, and the Bluetooth function will be turned OFF and the meter will disconnect from the APP.



4. OPERATING GUIDANCE

4.8 DATA LOGGING FUNCTION

This meter allows data to be recorded as well as reading data on a mobile device when it is paired to the Volt-100 using the CPS Link app.

4.8.1 Once connected to the VOLT-100 select the **TESTS** tab at the top of the app and then select Data Logging.

4.8.2 The app will instruct you to press the **RANGE** button to begin Data Logging. The log will store the last 1,000 events.

4.8.3 Once completed, the app will automatically store the log to a smartphone or tablet and offer the opportunity to view the log onscreen or export a report in CSV format.

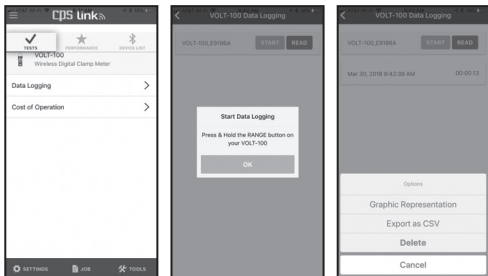

4.8.4 Data Recording: The meter can save up to 1,000 pieces of data. Long-press **REC/RANG** key to enable the meter to record data. The REC indicator on the LCD will be on, and the meter will store the current measurement data at the rate of 3 times/second. Long-press the **REC** key again to exit the data recording function. The meter also can exit the data recording function when up to 1,000 pieces of data are recorded or a key operation or position switch operation is performed.

4. OPERATING GUIDANCE

4.8.5 Data reading: This meter cannot support direct reading of stored data. It only supports reading of stored data with the Bluetooth function through the APP on a mobile device

4.9 ▼ FUNCTION

Short-press **LINK/REL/▼** in the harmonic measurement interface at **KW** and **W** position to scroll down, and to switch between the 1st harmonic and 20th harmonic. At the **KW** and **W** position, short-press the function key in the maximum/minimum value measurement interface to scroll down, and switch and display the maximum/minimum value.

4.10 ▲ FUNCTION

Short-press in the harmonic measurement interface at **KW** and **W** position to scroll up, and to switch between the 1st harmonic and 20th harmonic. At the **KW** and **W** position, short-press the function key in the maximum/minimum value measurement interface to scroll up, and switch and display the maximum/minimum value.

4.11 COST OF OPERATION

4.11.1 Once connected to the VOLT-100 select the TESTS tab at the top of the app and then select Cost of Operation.

4.11.2 The app will instruct you to turn the selector dial to **KW** and press start to calculate the cost of operation. The app calculates the cost based on a data feed of the local utility company rate for electricity.

4.11.3 Once completed, the app will automatically store the log to a smart device and offer the opportunity to view the log onscreen or export a report in CSV format.

4. OPERATING GUIDANCE

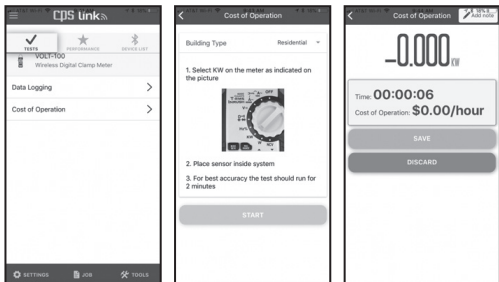

4.12 INRUSH MEASUREMENT



Long-press “Hz/%/INRUSH/▲” for more than 2 s at AC current position to enter the inrush measurement state.

4.13 BACK-LIGHT AND CLAMP LIGHTING

1. During measurement, if surrounding light is too dim to read the LCD display, press “BL/HOLD” for more than 2 seconds to turn the Backlight ON. The Backlight will automatically turn OFF after 20 seconds.
2. During this time, press the “BL/HOLD” key for 2 seconds to turn the Backlight OFF.
3. Turning ON the Backlight at a current position, the clamp lamp will turn ON at the same time.

The display Backlight will turn OFF after 30 seconds. However, battery life will be shortened with frequent use of the Backlight.

Note:

When battery voltage ≤ 7.2 V, the display will show the symbol “” (under-voltage). However, if the back-light is used, when battery voltage ≥ 7.2 V, battery voltage is reduced due to high working current and the display may show the symbol “” (when the symbol “” is displayed, measurement accuracy cannot be

4. OPERATING GUIDANCE

guaranteed). Under such conditions, the battery does not need to be replaced until the symbol “” is displayed without back-light.

4.14 AUTOMATIC SHUTDOWN

1. After startup, if the meter is not used within 30 minutes, it will enter a dormant state and shut down automatically to conserve battery life. One minute before shutdown, the meter will emit a short sound. After this time, the meter will shut down automatically.
2. After automatic shutdown, press the **FUNC** key and the meter will resume operation.
3. If the “**B.L/HOLD**” key is pressed during startup, the function of automatic shutdown will cancel automatically.

4.15 MEASUREMENT PREPARATION

1. Turn the change-over switch to power on the meter. If the battery is in under-voltage state (voltage ≤ 7.2 V), the display will show the symbol “

4.16 AC CURRENT MEASUREMENT

WARNING

ELECTRIC SHOCK.

REMOVE THE PROBE FROM THE METER BEFORE MEASURING WITH THE CURRENT CLAMP.

1. Turn the change-over switch to AC current position. At this time, the meter is in AC current measurement state, then select a suitable range.

4. OPERATING GUIDANCE

2. Hold the trigger, and open the clamp to clamp one conductor of measured circuits.
3. Read the current value from LCD display.

Note:

1. If two or more circuits of the measured circuits are clamped, the measurement result will be not correct.
2. In order to acquire the accurate reading, the measured conductor shall be in the center of clamp as far as possible.
3. “ Δ ” means that the maximum AC input current is 1,000 A.
4. When the reading is greater than 600.1 A at 60 A/600 A, there will be an alarm “beep” from the meter. When the reading is greater than 620 A rms, the ACA will display overload.
5. When the reading is greater than 1001 A at 1,000 A, there will be an alarm “beep” from the meter. When the reading is greater than 1,100 A rms, the ACA will display overload.

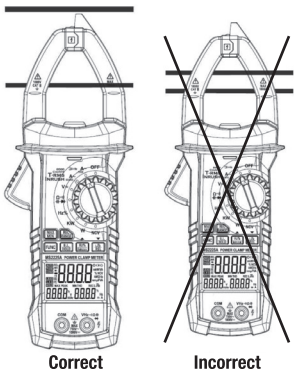

Figure “1” Schematic Diagram for Current Measurement at AC Position

4. OPERATING GUIDANCE

4.17 VOLTAGE MEASUREMENT



WARNING

ELECTRIC SHOCK.

PAY SPECIAL ATTENTION TO HIGH VOLTAGE MEASUREMENT TO AVOID ELECTRIC SHOCK.

DO NOT INPUT VOLTAGE WITH AN EFFECTIVE VALUE GREATER THAN AC 750.

1. Plug the black probe into the **COM** jack, plug the red probe into the **INPUT** jack, and select a suitable range.
2. Turn the change-over switch to AC/DC voltage position. In this case, the meter is in the DC voltage measurement state. If the AC voltage is to be measured, press the **FUNC** key and the meter will enter the AC voltage measurement state.
3. Connect the probe to both ends of voltage source or load to conduct measurement.
4. Read the voltage value from LCD.

Note:

1. *The auto range will be unavailable under the relative measurement mode.*
2. *“” means that the maximum input voltage is 750 V AC or 1,000 V DC.*
3. *There will be an alarm “beep” from the meter, when the measured reading of the meter is greater than 600 V rms ACV. When the reading is greater than 750 V rms ACV, the meter will display overload*
4. *There will be an alarm “beep” from the meter, when the measured reading of the meter is greater than 1,000 V rms DCV. When the reading is greater than 1100V rms, the DCV will display overload.*

4. OPERATING GUIDANCE

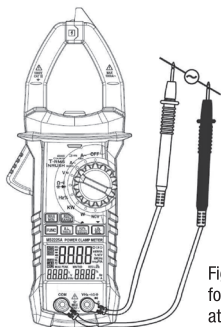

Figure “2” Schematic Diagram
for AC Voltage Measurement
at AC/DC Voltage Position

4.18 MEASURING FREQUENCY AND DUTY RATIO

1. Frequency measurement with clamp (at current gear):

⚠ WARNING

ELECTRIC SHOCK.

REMOVE THE PROBE FROM THE METER BEFORE MEASURING WITH THE CURRENT CLAMP.

- Turn the change-over switch to AC current position.
- Hold the trigger, and open the clamp to clamp one conductor of measured circuits.
- Press the “Hz/%INRUSH/▲” button shortly to switch into the status of frequency measurement.
- Read the frequency value from LCD display.
- Press “Hz/%INRUSH/▲” again to enter the status of duty ratio measurement

4. OPERATING GUIDANCE

Note:

1. If two or more circuits of the measured circuits are clamped, the measurement result will be not correct.
2. The measurement range of frequency is 10 Hz ~1 kHz. If the measured frequency is less than 10 Hz, the frequency greater than 10 kHz might be measured, but the accuracy of measurement cannot be guaranteed.
3. The measurement range of duty ratio is 10 ~ 95%.
4. The maximum input current of “

2. At voltage gear:

 **WARNING**

ELECTRIC SHOCK.

PAY SPECIAL ATTENTION TO HIGH VOLTAGE MEASUREMENT TO AVOID ELECTRIC SHOCK. DO NOT INPUT THE VOLTAGE WITH EFFECTIVE VALUE GREATER THAN AC 750.

- a. Insert the black probe into the **COM** jack, and insert the red probe into the **INPUT** jack.
- b. Turn the change-over switch to AC/DC voltage position, press **FUNC** to enter the status of AC voltage measurement.
- c. Press the “**Hz/%INRUSH/▲**” button to switch into the frequency measurement state.
- d. Connect the probe to both ends of signal source or load to conduct measurement.
- e. Read on the LCD.
- f. Press “**Hz/%INRUSH/▲**” again to enter the status of duty ratio measurement.

Note:

1. The measurement range of frequency is 10 Hz ~ 10kHz. If the measured frequency is less than 10 Hz, the LCD will display “00.0”, the frequency less than 10 kHz might be measured, but the accuracy of measurement cannot be guaranteed.

4. OPERATING GUIDANCE

- 2. The measurement range of duty ratio is 10 ~ 95%.*
- 3. The maximum input voltage of “ ” is 750 V AC (effective value).*
3. At HZ/DUTY gear:

WARNING

ELECTRIC SHOCK.

PAY SPECIAL ATTENTION TO HIGH VOLTAGE MEASUREMENT TO AVOID ELECTRIC SHOCK.

DO NOT INPUT VOLTAGE WITH EFFECTIVE VALUE GREATER THAN AC 750 V.

- Insert the black probe into the **COM** jack, and insert the red probe into the **INPUT** jack.
- Turn the change-over switch to HZ% position.
- Connect the probe to both ends of signal source or load to conduct measurement.
- Read on the LCD.
- Press “Hz/%INRUSH/▲” again to enter the status of duty ratio measurement.

Note:

The measurement range of frequency is 10 Hz ~ 9.999 MHz, if the measured frequency less than 10 Hz, the LCD will display “00.0”; the frequency greater than 9.999 MHz might be measured, but the accuracy of measurement cannot be guaranteed.

4. OPERATING GUIDANCE

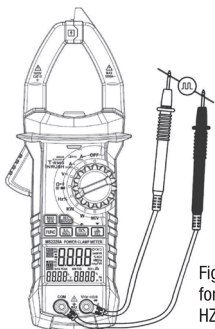

Figure "3" Schematic Diagram for Frequency Measurement at HZ% Position

4.19 RESISTANCE MEASUREMENT

⚠ WARNING

WHEN MEASURING THE IMPEDANCE ON THE CIRCUIT, THE CIRCUIT POWER SHOULD BE DISCONNECTED, AND THE CAPACITOR IN THE CIRCUIT SHOULD BE COMPLETELY DISCHARGED.

1. Insert the black probe into the **COM** jack, and insert the red probe into the **INPUT** jack.
2. Place the change-over switch on the **▶ •|||** position, and set the meter in the status of resistance measurement.
3. Connect probes to both ends of the measured resistor or the circuit for measurement.
4. Read values on the LCD display.

4. OPERATING GUIDANCE

Note:

1. When the input is open-circuited, the LCD will display “OL” for over range.
2. If the resistance of measured resistor is greater than $1\text{ M}\Omega$, the reading of the meter might be stable after a few seconds, and it is common for high resistance readings.

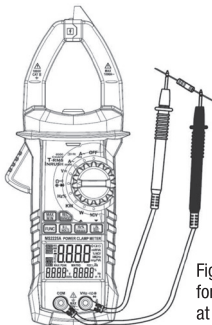

Figure “4” Schematic Diagram for Resistance Measurement at Position

4.20 DIODE TEST

1. Insert the black probe into the **COM** jack, and insert the red probe into the **INPUT** jack.
2. Turn the change-over switch to the $\rightarrow \bullet \rightarrow$ position.
3. Press “**FUNC**” to switch into the status of $\rightarrow \bullet \rightarrow$ measurement.
4. Connect the red probe to the positive pole of the diode, and connect the black probe to the negative pole for measurement.
5. Read on the LCD.

4. OPERATING GUIDANCE

Note:

1. The approximate value of the forward voltage drop of diode will be displayed on the meter.
2. If the probe is connected inversely or the probe is open-circuited, the LCD will display “OL”.

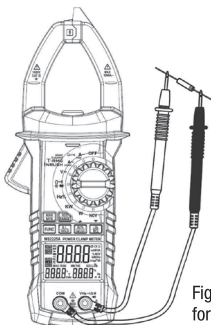

Figure “5” Schematic Diagram
for Diode Testing at Position

4.21 CIRCUIT CONTINUITY TEST

⚠ WARNING

ELECTRIC SHOCK.

FOR THE CIRCUIT CONTINUITY TEST, THE CIRCUIT POWER SHOULD BE DISCONNECTED, AND THE CAPACITOR IN THE CIRCUIT SHOULD BE COMPLETELY DISCHARGED.

4. OPERATING GUIDANCE

1. Insert the black probe into the **COM** jack, and insert the red probe into the **INPUT** jack.
2. Turn the change-over switch to the $\rightarrow \bullet \cdot \cdot \cdot$ gear.
3. Press “**FUNC**” button to switch to the status of circuit continuity testing.
4. Connect probes to both ends of the circuit for measurement.
5. If the resistance of measured circuit is less than 50Ω , the buzzer inside the meter will sound.
6. Read the resistance value of the circuit on the LCD display.

Note:

If the probe is open-circuited or the resistance of the measured circuit is greater than 600Ω , the “OL” will be displayed.

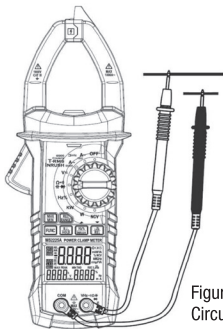

Figure “6” Schematic Diagram for Circuit Continuity Test at Position

4. OPERATING GUIDANCE

4.22 CAPACITANCE MEASUREMENT

⚠ WARNING

ELECTRIC SHOCK.

TO AVOID ELECTRIC SHOCK, THE CAPACITOR SHOULD BE COMPLETELY DISCHARGED BEFORE THE CAPACITANCE MEASUREMENT.

1. Insert the black probe into the **COM** jack, and insert the red probe into the **INPUT** jack.
2. Turn the change-over switch to the **→ •••** position.
3. Connect the probe to the both ends of the measured capacitor for measurement after the capacitor is completely discharged.
4. Read the capacitance value on the display.

Note:

To improve the accuracy of the measured value less than 10 nF, the distributed capacitance of the meter and conductors should be subtracted.

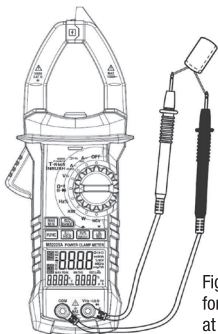

Figure "7" Schematic Diagram for Capacitance Measurement at Position

4. OPERATING GUIDANCE

4.23 MEASUREMENT OF INRUSH CURRENT



WARNING

ELECTRIC SHOCK.

REMOVE THE PROBE FROM THE METER BEFORE MEASURING WITH THE CURRENT CLAMP.

1. Turn the change-over switch to 60/600 A or 1000 A AC current position.
2. Hold the trigger, and open the clamp to clamp one conductor of measured circuits.
3. Long press the “HZ%/INRUSH/▲” button more than 2 seconds to enter the mode of inrush current measurement. Then the LCD will display “INR”, and the meter will display and hold the inrush current value until motor start-up is detected.
4. Read the inrush current value from LCD display.

Note:

1. *If two or more circuits of the measured circuits are clamped, the measurement result will be not correct.*
2. *In order to acquire the accurate reading, the measured conductor shall be in the center of clamp as far as possible.*
3. *The LCD only displays “OL” in the manual range mode indicating the over range, and the higher range should be selected.*
4. *Under the manual range mode, if the measured value is not known in advance, the highest level should be set for the range.*
5. *“▲” means that the maximum input current is 1000A AC (effective value).*

4. OPERATING GUIDANCE

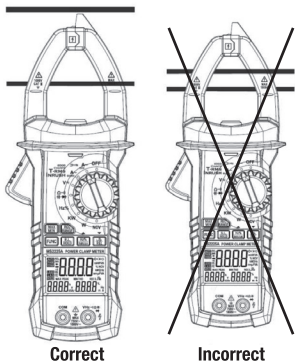

Figure “8” Schematic Diagram for Inrush Current Measurement at AC Current Position

4.24 NCV MEASUREMENT

1. Turn the change-over switch to the NCV position.
2. The top of the meter should be arranged near the conductor.
When the detected voltage is greater than 110 Vac (RMS), the voltage sensing indicator may be on, and the buzzer may “beep”.

Note:

1. *Voltage may still exist even without instructions. Do not determine whether there is voltage in the conductor only by using the noncontact voltage detectors. The detecting operation might be affected by the socket design, insulation thickness, type and other factors.*
2. *When there is input voltage to the input terminal of the meter, the voltage sensing indicator may also be on.*

4. OPERATING GUIDANCE

3. *Intrusive sources (such flashlight, motor, etc.) in the external environment may cause a wrong trigger of non-contact voltage detection.*

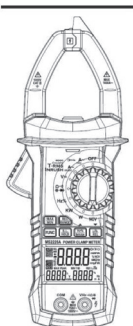

Figure “9” Schematic Diagram
for Voltage Detection at NCV
Positon

4.25 ACTIVE POWER MEASUREMENT

⚠ WARNING

ELECTRIC SHOCK.

PAY SPECIAL ATTENTION TO HIGH VOLTAGE AND HIGH CURRENT MEASUREMENT TO AVOID ELECTRIC SHOCK.

DO NOT INPUT THE VOLTAGE WITH THE EFFECTIVE VALUE GREATER THAN AC 750 AND THE CURRENT WITH THE EFFECTIVE VALUE GREATER THAN 1,000 A.

4. OPERATING GUIDANCE

1. Turn the change-over switch to kW or W position.
2. Clamp the measured conductor of the power supply or load with the clamp. Input the measured voltage from the V end and COM end. After the measuring circuits are connected correctly, the active power shall be read from the LCD and the LCD displays the effective values of measured voltage and current simultaneously.
3. Determine whether the switch shall be turned to the KW position or W position according to the measured current. At the W position, the measurement range of current is 1 mA - 4,000 mA and at the KW gear, the measurement range of current is 1 A - 1,000 A. The measurement range of voltage at both the KW gear and W position is 1 V -750 V.
4. Press **MAX/MIN** key in the active power measurement interface to enter the maximum/minimum value measurement mode, and the LCD will display the measured value of active power and the maximum and minimum values of active power within a certain period simultaneously. Press the **Hz/%INRUSH/▲** key or **LINK/REL/▼** key again in this interface, the LCD will display the recording time and real-time measurement value of active power.

Note:

1. *The maximum measurement range of active power is 750 kW, and the LCD will display OL for over range.*
2. *The maximum measured current is 4,000 mA at W gear. Please do not operate by mistake.*
3. *The minimum measured voltage is 1 V and the minimum measured current is 1 mA.*
4. *The maximum measured voltage is 750 V and the maximum measured current is 1,000 A.*

4. OPERATING GUIDANCE

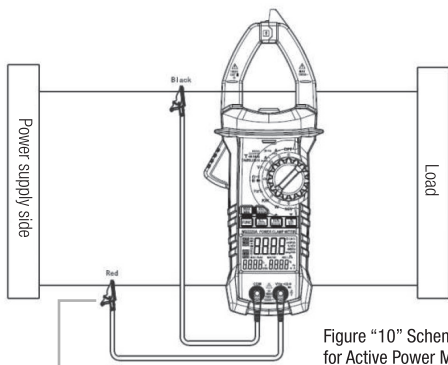

Clamps Probes
(Purchased Separately)

Figure "10" Schematic Diagram
for Active Power Measurement
at KW Position

4.26 APPARENT POWER MEASUREMENT



WARNING

ELECTRIC SHOCK.

PAY SPECIAL ATTENTION TO HIGH VOLTAGE AND HIGH CURRENT MEASUREMENT TO AVOID ELECTRIC SHOCK.

DO NOT INPUT THE VOLTAGE WITH THE EFFECTIVE VALUE GREATER THAN AC 750 AND THE CURRENT WITH THE EFFECTIVE VALUE GREATER THAN 1,000 A.

4. OPERATING GUIDANCE

1. Turn the change-over switch to the kW or W position, press the **FUNC** key to enter the apparent power measurement interface.
2. Clamp the measured conductor of the power supply or load with the clamp (purchased separately). Input the measured voltage from the **V** end and **COM** end. After the measuring circuits are connected correctly, read the apparent power from the LCD and the LCD displays the effective values of measured voltage and current simultaneously.
3. Determine whether the switch shall be turned to the KW position or W position according to the measured current. At the W position, the measurement range of current is 1 mA - 4,000 mA and at the KW position, the measurement range of current is 1 A - 1,000 A. The measurement range of voltage at both the KW position and W position is 1 V - 750 V.
4. Press **MAX/MIN** key in the apparent power measurement interface to enter the maximum/minimum value measurement mode, and the LCD will display the measured value of apparent power and the maximum and minimum values of apparent power within a certain period simultaneously. Press the **Hz/%INRUSH/▲** key or **LINK/REL/▼** key once again in this interface. The LCD will display the recording time and real-time measurement value of apparent power.

Note:

1. *The maximum measurement range of apparent power is 750 kW, and the LCD will display OL for over range.*
2. *The maximum measured current is 4,000 mA at W gear. Please do not operate by mistake.*

WARNING

ELECTRIC SHOCK.

PAY SPECIAL ATTENTION TO HIGH VOLTAGE AND HIGH CURRENT MEASUREMENT TO AVOID ELECTRIC SHOCK.

DO NOT INPUT THE VOLTAGE WITH THE EFFECTIVE VALUE GREATER THAN AC 750 AND THE CURRENT WITH THE EFFECTIVE VALUE GREATER THAN 1,000 A.

4. OPERATING GUIDANCE

3. The minimum measured voltage is 1 V and the minimum measured current is 1 mA.
4. The maximum measured voltage is 750 V and the maximum measured current is 1,000 A.

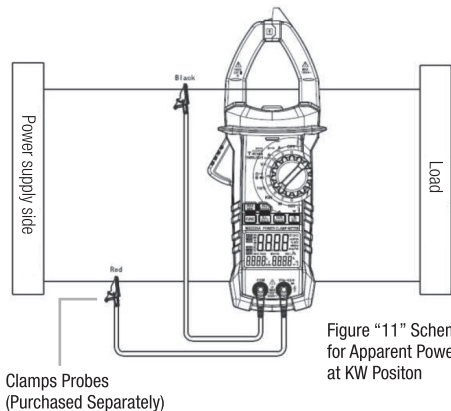

Figure "11" Schematic Diagram
for Apparent Power Measurement
at KW Position

4.27 POWER FACTOR MEASUREMENT

1. Turn the change-over switch to the kW or W position, press the **FUNC** key to enter the power factor measurement interface.
2. Clamp the measured conductor of the power supply or load with the clamp. Input the measured voltage from the V end and COM end. After the measuring circuits are connected correctly, the power factor from the LCD shall be read and the LCD displays the value of reactive power simultaneously.
3. Determine whether the switch shall be turned to the KW position or W position according to the measured current. At the W

4. OPERATING GUIDANCE

position, the measurement range of current is 1 mA - 4,000 mA and at the KW position, the measurement range of current is 1 A - 1,000 A. The measurement range of voltage at both the KW position and W position is 1 V - 750 V.

- There is a phase difference between the voltage value and current value of the inductive load and capacitive load. Generally, the power factor is indicated by the cosine $\text{COS}\phi$ of phase angle ϕ . When the power factor is negative, it means that the measured load is capacitive load.
- The reactive power is an indirectly measured value. The computation formula of kVar is: $\text{kVar}^2 = \text{kVA}^2 - \text{kW}^2$, and the value is calculated with the measured voltage, current and active power value.

Note:

- The maximum measured current is 4,000 mA at W position. Please do not operate by mistake.
- The minimum measured voltage is 1 V and the minimum measured current is 1 mA.
- The maximum measured voltage is 750 V and the maximum measured current is 1,000 A.

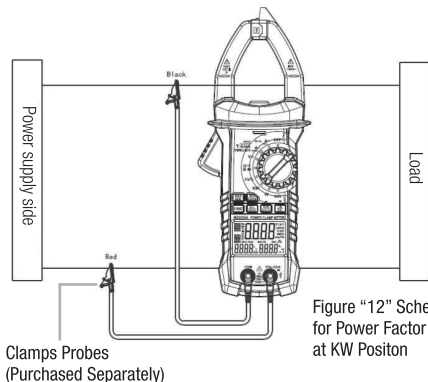

Figure "12" Schematic Diagram
for Power Factor Measurement
at KW Position

4. OPERATING GUIDANCE

4.28 PHASE ANGLE MEASUREMENT



WARNING

ELECTRIC SHOCK.

PAY SPECIAL ATTENTION TO HIGH VOLTAGE AND HIGH CURRENT MEASUREMENT TO AVOID ELECTRIC SHOCK.

1. Turn the change-over switch to the kW or W position, press the **FUNC** key to enter the phase angle measurement interface.
2. Clamp the measured conductor of the power supply or load with the clamp. Input the measured voltage from the V end and COM end. After the measuring circuits are connected correctly, the phase angle shall be read from the LCD and the LCD displays the effective values of measured voltage and current simultaneously.
3. Determine whether the switch shall be turned to the KW position or W position according to the measured current. At the W position, the measurement range of current is 1 mA - 4,000 mA and at the KW position, the measurement range of current is 1 A - 1,000 A. The measurement range of voltage at both the KW gear and W position is 1 V -750 V.
4. There is a phase difference between the voltage value and current value of the inductive load and capacitive load. Generally, the phase difference is indicated by the phase angle ϕ .

Note:

1. *The maximum measured current is 4,000 mA at W gear. Please do not operate by mistake.*
2. *The minimum measured voltage is 1 V and the minimum measured current is 1 mA.*
3. *The maximum measured voltage is 750 V and the maximum measured current is 1,000 A.*

4. OPERATING GUIDANCE

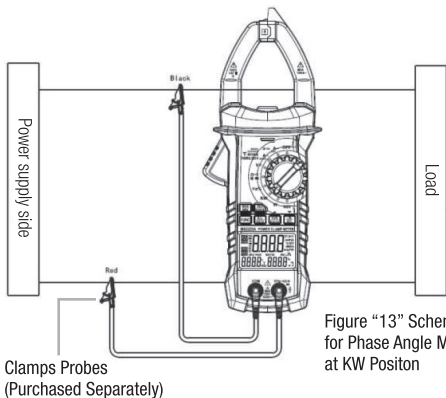

Figure "13" Schematic Diagram
for Phase Angle Measurement
at kW Position

4.29 HARMONICS MEASUREMENT (VOLTAGE SIGNAL)



WARNING

ELECTRIC SHOCK.

PAY SPECIAL ATTENTION TO HIGH VOLTAGE MEASUREMENT TO
AVOID ELECTRIC SHOCK.

DO NOT INPUT VOLTAGE WITH THE EFFECTIVE VALUE GREATER THAN
AC 750.

1. Turn the change-over switch to the kW or W position, first long-press the **FUNC** key to enter the voltage measurement interface, and then short-press the **FUNC** key to enter the harmonics measurement interface, and switch from 1st - 20th harmonic through pressing the Hz/%INRUSH/▲ key or LINK/REL/▼ key.

4. OPERATING GUIDANCE

2. Input the measured voltage signal from the V end and COM end.
3. After the measuring circuits are connected correctly, the effective value of the nth harmonic component shall be read.
4. Short-press the **FUNC** key in the harmonic measurement interface once again to enter into THDR (relative to the actual effective value) or THD-F (relative to the fundamental wave) measurement mode. The main interface displays the effective value of the nth harmonic component and the minor interface displays the total harmonic distortion.
5. Press **MAX/MIN** key in the voltage measurement interface to enter the maximum/minimum value measurement mode. In this case, the main interface displays the measured effective value of voltage and the minor interface displays the maximum and minimum values within a certain period. Press the **Hz/%INRUSH/▲** key or **LINK/REL/▼** key again in this interface to enter into the time recording interface. In this case, the main interface displays the limited voltage measurements, and the minor interface displays the time of maximum and minimum values.

Note:

1. *The minimum measured voltage is 1 V and the maximum measured voltage is 750 V. This interface will display OL for over 750 V.*



WARNING

ELECTRIC SHOCK.

PAY SPECIAL ATTENTION TO HIGH CURRENT MEASUREMENT TO AVOID ELECTRIC SHOCK.

DO NOT INPUT THE CURRENT WITH THE EFFECTIVE VALUE GREATER THAN AC 1,000 A.

4. OPERATING GUIDANCE

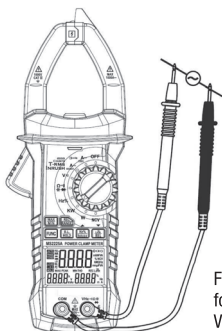

Figure “14” Schematic Diagram for Harmonics Measurement of Voltage Signal at KW Position

4.30 HARMONICS MEASUREMENT (CURRENT SIGNAL)

1. Turn the change-over switch to the kW or W position, first long-press the **FUNC** key to enter the current measurement interface, and then short-press the **FUNC** key to enter into the harmonics measurement interface, and switch from 1st - 20th harmonic through pressing the **Hz/%INRUSH/▲** key or **LINK/REL/▼** key.
2. Clamp the measured conductor of the power supply or load with the clamp.
3. After the measuring circuits are connected correctly, the effective value of the nth harmonic component shall be read.
4. Short-press the **FUNC** key in the harmonic measurement interface once again to enter into THD-R (relative to the actual effective value) or THD-F (relative to the fundamental wave) measurement mode. The main interface displays the effective value of the nth harmonic component and the minor interface displays the total harmonic distortion.

4. OPERATING GUIDANCE

5. Press **MAX/MIN** key in the current measurement interface to enter the maximum/minimum value measurement mode. In this case, the main interface displays the measured effective value of current and the minor interface displays the maximum and minimum values within a certain period. Press the **Hz/%INRUSH/▲** key or **LINK/REL/▼** key again in this interface to enter into the time recording interface. In this case, the main interface displays the limited voltage measurements, and the minor interface displays the time of maximum and minimum values.

Note:

1. The minimum measured current is 1 mA and the maximum measured current is 1,000 A. This interface will display OL for over 1,000 A.

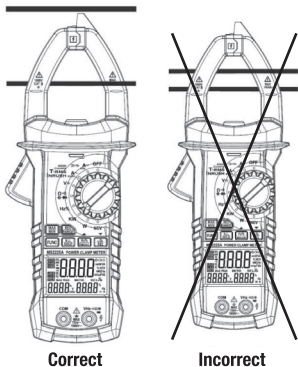

Figure “15” Schematic Diagram for Harmonics Measurement of Current Signal at KW Position

5. MAINTENANCE

Note:

1. Even if no indication, voltage may exist still. Do not use a non-contact voltage detector to judge whether there is voltage in the wire. Detection operation could be affected by socket design, insulation thickness, type and other factors.
2. When inputting voltage on the meter input terminal, due to the existence of induced voltage, the voltage induction indicator also may light.
3. External sources of interference (such as flashlight, motor, etc.) may incorrectly trigger non-contact voltage detection.

5.1 BATTERY REPLACEMENT

WARNING

TO AVOID ELECTRIC SHOCK, MAKE SURE THAT THE TEST LEADS HAVE BEEN CLEARLY MOVED AWAY FROM THE CIRCUIT UNDER MEASUREMENT BEFORE OPENING THE BATTERY COVER.

1. If the meter displays the symbol “” replace the battery immediately.
2. Unscrew the fastening screw on the battery cover and remove it.
3. Replace the old battery.
4. Install the battery cover in the original position.

Note:

Do NOT reverse battery polarity.

5.2 PROBE REPLACEMENT

Do not use a probe with damage or wear trace (exposing the white layer). Replace immediately if worn.

A probe with a damaged insulating layer and exposed metal conductor wire must be replaced (See 6. ACCESSORIES).

5. MAINTENANCE

WARNING

USE MEETS EN 61010-031 STANDARD, RATED CAT III 1000V, OR BETTER TEST LEADS.

WARNING

TO AVOID ELECTRIC SHOCK, MAKE SURE PROBES ARE DISCONNECTED FROM THE MEASURED CIRCUIT BEFORE REMOVING THE REAR COVER. MAKE SURE THE REAR COVER IS FIRMLY ATTACHED BEFORE USING THE INSTRUMENT.

5.3 CALIBRATION

This meter should be recalibrated annually within a temperature range of 65°F to 83°F (18°C to 28°C) and relative humidity less than 75%.

6. ACCESSORIES

Description	Part #	Qty
Test Lead Probe: CAT 3, 750V AC, 1000V DC	DMXTL	1 pair
Clamp Probe & Test Lead Probe: CAT 3, 750V AC, 1000V DC	DMXCP	Order Separately
Owner's Manual		1 copy
Battery 6F22 9VOLTS		1
Protective Storage Case		1

WARRANTY

CPS Products, Inc. guarantees that all products are free of manufacturing and material defects to the original owner for one year from the date of purchase. If the equipment should fail during the guarantee period it will be repaired or replaced (at our option) at no charge. This guarantee does not apply to equipment that has been altered, misused or solely in need of field service maintenance. All repaired equipment will carry an independent 90-day warranty. This repair policy does not include equipment that is determined to be beyond economical repair.



www.cpsproducts.com



CPS PRODUCTS, INC. U.S.A. (Headquarters)
1010 East 31st Street, Hialeah, Florida 33013, USA
Tel: 305-687-4121, 1-800-277-3808
Fax: 305-687-3743
E-mail: info@cpsproducts.com
Website: www.cpsproducts.com

CPS PRODUCTS CANADA LTD.
1324 Blundell Road Mississauga, ON, L4Y 1M5
Tel: 905.615.8620, Fax: 905.615.9745
E-mail: info@cpsproducts.com
Website: www.cpsproducts.com

CPS PRODUCTS N.V
Krijgsbaan 241, 2070
Zwijndrecht, Belgium
Tel: (323) 281 30 40,
E-mail: info@cpsproducts.be

CPS AUSTRALIA PTY. LTD.
109 Welland Avenue,
Welland, South Australia 5007
Tel: +61 8 8340 7055,
E-mail: sales@cpsaustralia.com.au