

UNEK6165GK

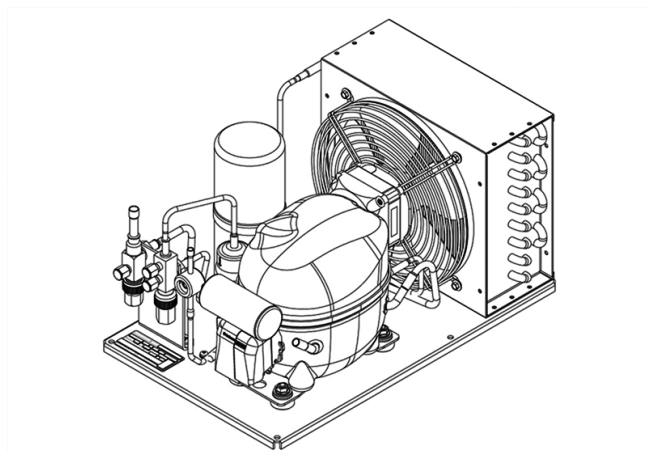

ENGINEERING CODE
557IA5212AA



REFRIGERANT
R-404A



POWER SUPPLY
220-240 V 50 Hz



APPLICATION
HBP



MOTOR TYPE
CSIR



STANDARD
EN13215_RG20



COOLING CAPACITY
567 W



EFFICIENCY
1.44 W/W

CE

ECODESIGN COMPLIANT

DATA

GENERAL DATA

Model UNEK6165GK

ACCESSORIES

Discharge valve FLARE 1/4" 2110025

Suction valve FLARE 3/8" 2110024

CONDENSING COMPONENTS

Compressor NEK6165GK M/HBP

Condenser 3R9T 2451205

Refrigerant R-404A

Expansion Device C-V

Fan Blade Diameter 230

Fankit 10W 230/31/5B 1996699

MECHANICAL DATA

Air Flow	420 m ³ /h
Height	254 mm
Receiver	1.1 L
Shaft Power	10
Weight	16 Kg
Width	300 mm
Length	435 mm

PERFORMANCE

TESTED CONDITIONS

Tested Refrigerant	R-404A
Tested Application	HBP
Tested Standard	EN13215_RG20

RATED POINTS

Ambient Temperature °C	Evaporating Temperature °C	Cooling Capacity W	Efficiency W/W	Consumo de Potencia W
32	-10	567	1.44	395

Test Condition: Subcooling 3 K, Return Gas 20 °C.

PERFORMANCE CURVE

Ambient Temperature 25°C

Evaporating Temperature °C	Cooling Capacity W	Efficiency W/W	Consumo de Potencia W
-20	480	1.34	357
-15	583	1.52	384
-5	835	1.88	444
0	984	2.07	475
5	1145	2.26	507
10	1319	2.45	539

Test Condition: Subcooling 3 K, Return Gas 20 °C.

PERFORMANCE CURVE

Ambient Temperature 32°C

Evaporating Temperature °C	Cooling Capacity W	Efficiency W/W	Consumo de Potencia W
-20	427	1.32	322
-15	490	1.37	357
-5	658	1.52	433
0	762	1.61	473
5	878	1.71	513
10	1005	1.82	554

Test Condition: Subcooling 3 K, Return Gas 20 °C.

PERFORMANCE CURVE

Ambient Temperature 43°C

Evaporating Temperature °C	Cooling Capacity W	Efficiency W/W	Consumo de Potencia W
-20	389	1.02	380
-15	476	1.13	423
-5	685	1.33	514
0	806	1.44	561
5	937	1.54	609

Test Condition: Subcooling 3 K, Return Gas 20 °C.

ENVELOPE

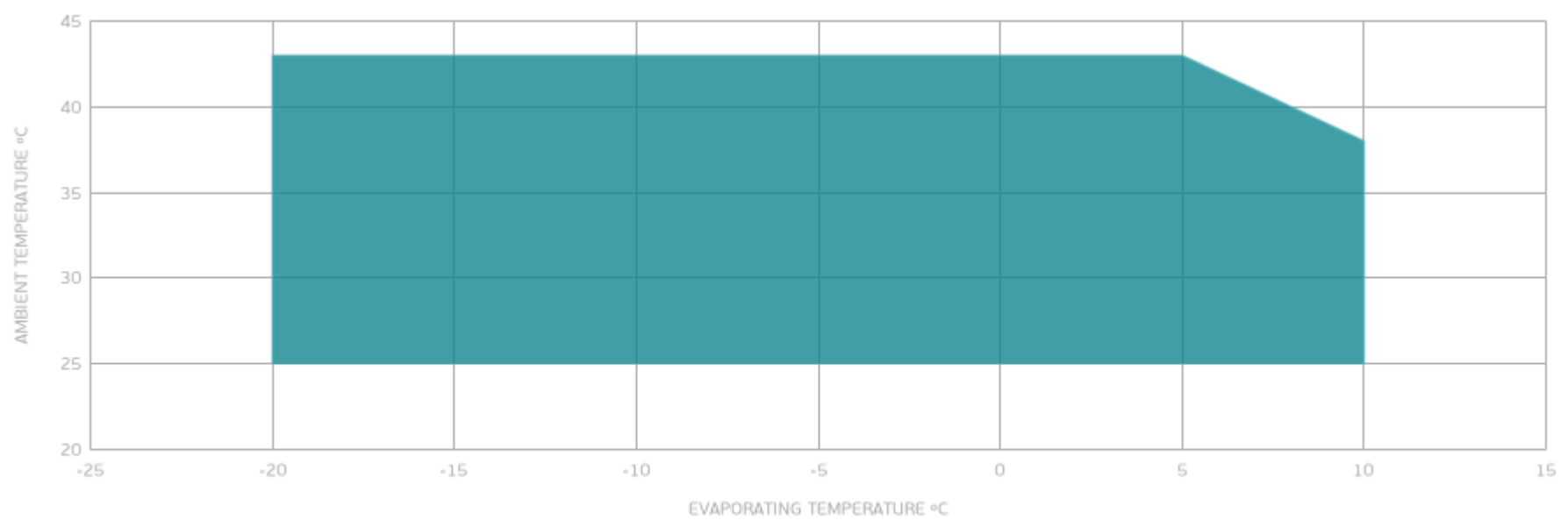

■ OPERATING CONDITION

EXTERNAL DIMENSIONS

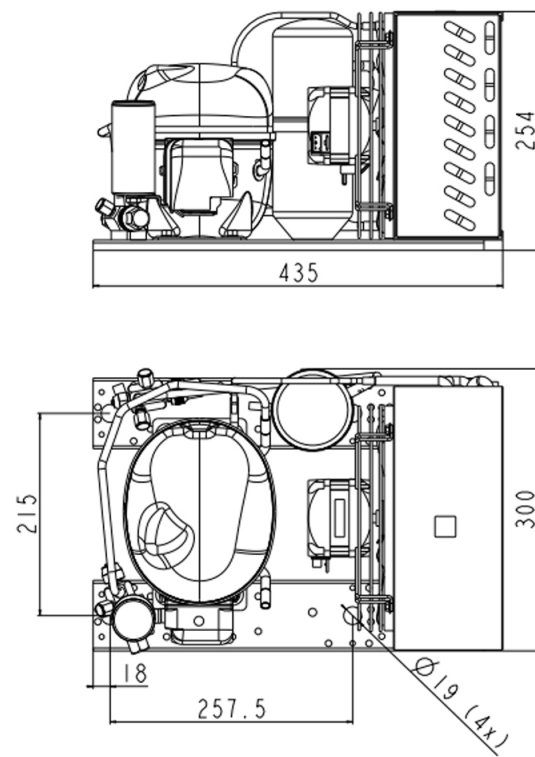

WIRING DIAGRAM

