

UNJ6220Z

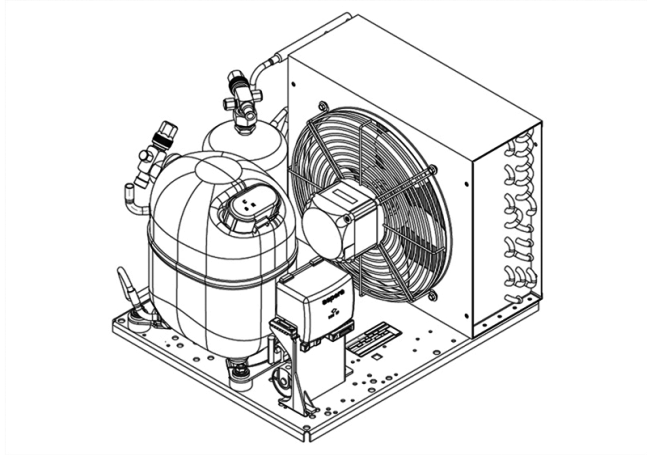

ENGINEERING CODE
644HA5604AA



POWER SUPPLY
220-240 V 50 Hz



MOTOR TYPE
CSR



REFRIGERANT
R-134a



APPLICATION
HBP



STANDARD
EN13215_RG20



COOLING CAPACITY
1252 W



EFFICIENCY
1.64 W/W

CE

ECODESIGN COMPLIANT

DATA

GENERAL DATA

Model UNJ6220Z

ACCESSORIES

Discharge valve	SOLDER 3/8"	2110049
Suction valve	SOLDER 1/2"	2110050

CONDENSING COMPONENTS

Compressor	NJ6220Z	M/HBP
Condenser	3R12T	2451140
Refrigerant	R-134a	
Expansion Device	C-V	
Fan Blade Diameter	275	
Fankit	34W 275/31/5B	1996583

MECHANICAL DATA

Air Flow	640 m ³ /h
Height	324 mm
Receiver	2.3 L
Shaft Power	34
Weight	37 Kg
Width	410 mm
Length	481 mm

PERFORMANCE

TESTED CONDITIONS

Tested Refrigerant	R-134a
Tested Application	HBP
Tested Standard	EN13215_RG20

RATED POINTS

Ambient Temperature °C	Evaporating Temperature °C	Cooling Capacity W	Efficiency W/W	Consumo de Potencia W
32	-10	1252	1.64	765

Test Condition: Subcooling 3 K, Return Gas 20 °C.

PERFORMANCE CURVE

Ambient Temperature 25°C

Evaporating Temperature °C	Cooling Capacity W	Efficiency W/W	Consumo de Potencia W
-15	1101	1.64	671
-5	1702	2.07	821
0	2056	2.26	910
5	2443	2.42	1008
10	2864	2.57	1116

Test Condition: Subcooling 3 K, Return Gas 20 °C.

PERFORMANCE CURVE

Ambient Temperature 32°C

Evaporating Temperature °C	Cooling Capacity W	Efficiency W/W	Consumo de Potencia W
-15	992	1.45	686
-5	1543	1.81	852
0	1865	1.97	949
5	2216	2.10	1054
10	2595	2.22	1168

Test Condition: Subcooling 3 K, Return Gas 20 °C.

PERFORMANCE CURVE

Ambient Temperature 43°C

Evaporating Temperature °C	Cooling Capacity W	Efficiency W/W	Consumo de Potencia W
-15	800	1.14	704
-5	1300	1.46	891
0	1585	1.59	996
5	1892	1.71	1109

Test Condition: Subcooling 3 K, Return Gas 20 °C.

ENVELOPE

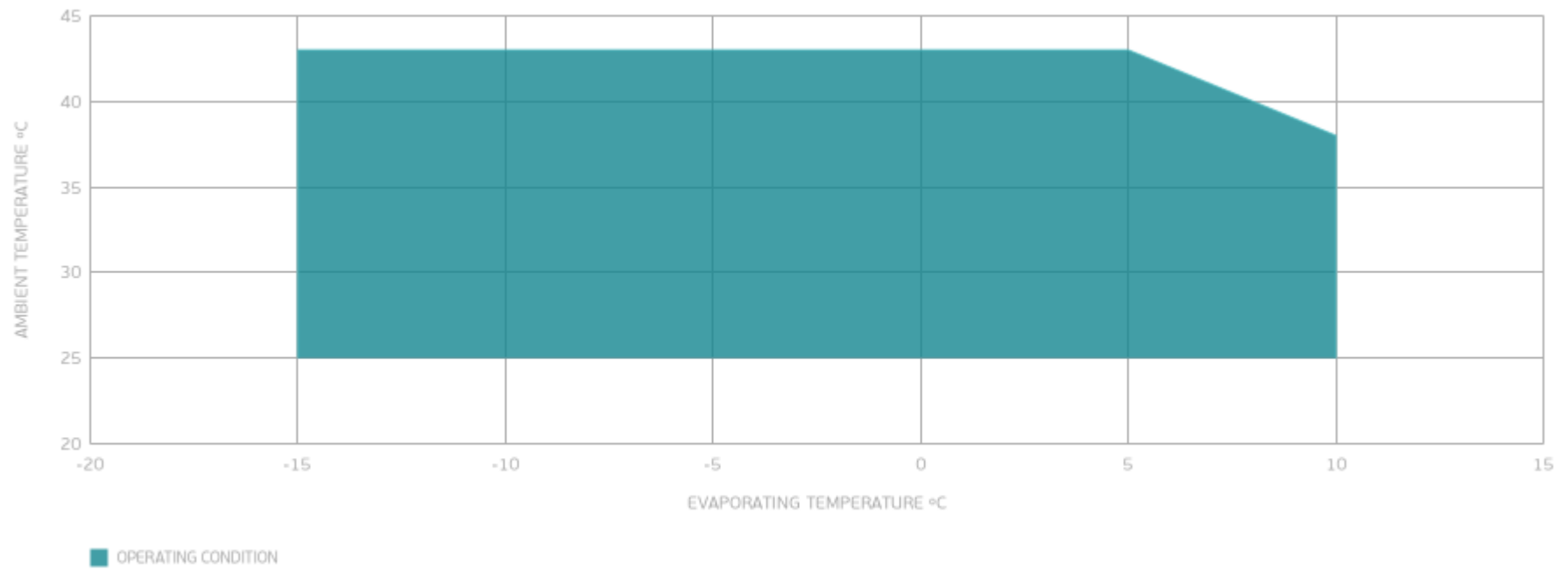

EXTERNAL DIMENSIONS

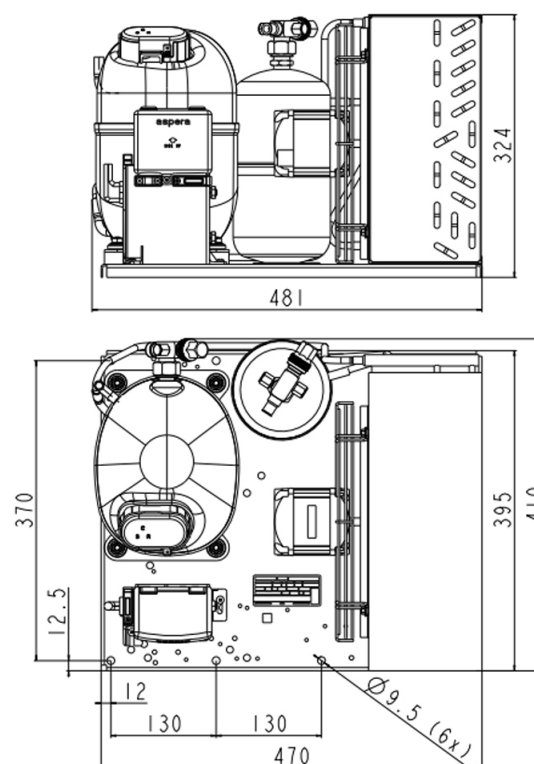

WIRING DIAGRAM

