

Optional function parts

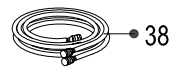

38



39

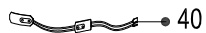

40



41

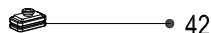

42



43

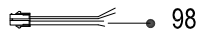

98



99

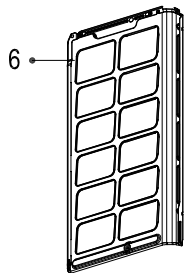

6

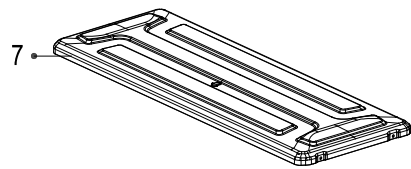

7

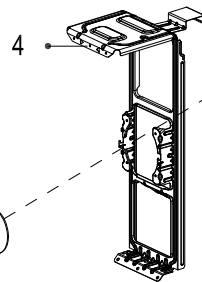

4

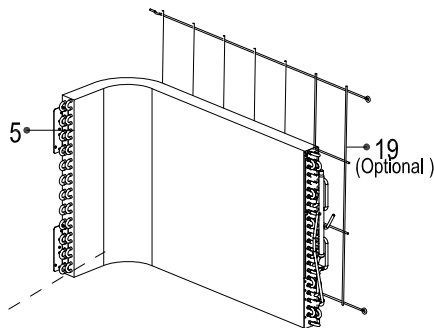

5

19
(Optional)

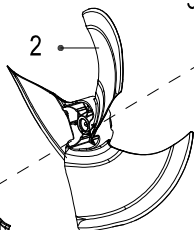

2

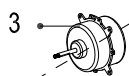

3

1

1.2

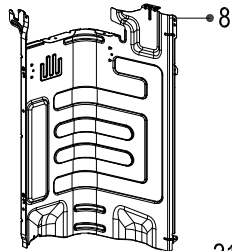
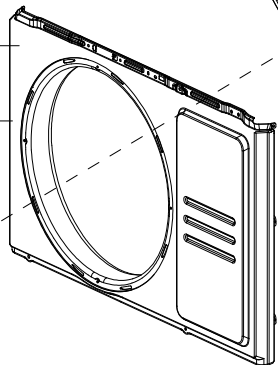

8

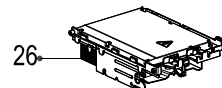

26



26.1

For fully
assembled

26.2

26.3



25



12

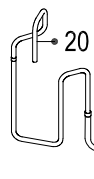

20

for cooling only

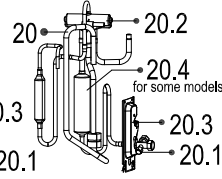

20

20.2

20.3

20.1

for some models

for heat pump

24

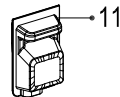

11

For some models



15



16



17



23

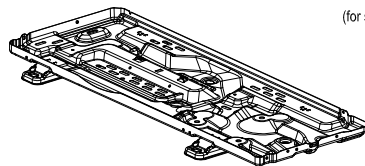

13

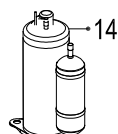

14

21.2
(for some models)

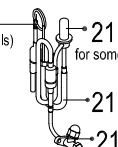

21

21.1

21.5
for some models

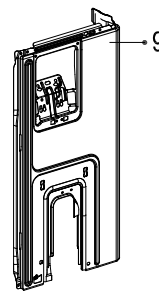

9

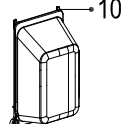

10

Exploded View

产品编码(Product model) : 22022516001742
 客户编码(Customer No) : G0011405
 客户型号(Customer model) : KOX330-18HFN32X
 订单编码(Order Product Code) : 62225-D3435302

EX_ID	Spare Parts Code	Part Name(CN)	Part Name(EN)	Qty.	Remark2	Part Status	Drawing No	MIN_ORDER_QTY	Long Term Material(Y or N)	High Rate of Replacement(Y or N)	SB Type	Replace Type	Remarks
1	12222000013385	前面板部件	Front panel assembly	1		In Use	WX301.BJ.1A	1					
1.1	12122000026241	出风网罩	Air outlet grille	1		In Use	WX301.SL.2	1					
1.2	12222000013386	前面板	Front panel	1		In Use	WX301.BJ.1A-1	1					
2	12100105000881	轴流风叶	Axial flow fan	1		In Use	ZL-434*144*8-3KN	1					
3	11002015012128	无刷直流电机	Brushless DC Motor	1		In Use	ZKFN-34-10-1-3						
4	12222000013200	电机支架 RoHS WX301.BJ.3-1	Supporter of fan motor	1		In Use	WX301.BJ.3-1	1					
5	15822000010396	冷凝器部件	Condenser assembly	1		In Use	EU-KFR50W/BP3N8-X301(RD0).ZL.1	1					
6	12222000013197	左侧板	Left supporter	1		In Use	WX301.BJ-6	1					
7	12222000013193	顶盖部件	Top cover assembly	1		In Use	WX301.BJ.2	1					
8	12222000014125	隔板部件	Partition board assembly	1		In Use	WX301.BJ.9	1					
9	12222000013190	右侧板部件	Right clapboard assembly	1		In Use	WX301.BJ.4	1					
10	12122000007150	接水盖	Water collector	1		In Use	BA01.SL-2	1					
11	12122000027482	大把手	Big handle	1		In Use	W110.3.1D	1					
12	17400401000075	接线座(5位)UL认证	Terminal	1		In Use	JXZ-PT5H-A	1					
13	12222000013204	底盘部件	Chassis assembly	1		In Use	WX301.BJ.5	1					
14	11103020003919	变频旋转式压缩机	DC Inverter Rotary Compressor	1		In Use	KSN140D21UFZ						
20	15422000017792	四通阀部件	4-way valve assembly	1		In Use	EU-KFR50W/BP3N8-X301(RD0).ZL.2	1					
20.1	15500204000058	低压阀	Gas valve	1		In Use	DYF-B29N	1					
20.2	15500216001783	四通阀	4-way valve	1		In Use	STF-02BN1(VHR)	1					
20.3	12222000005738	阀安装板	Valve plate	1		In Use	KFR-72W-X401-1	1					
21	15422000004932	高压阀部件 RoHS EU-KFR26W/BP3N1-B01(RD1)-W.ZL.1	Liquid valve assembly	1		In Use	EU-KFR26W/BP3N1-B01(RD1)-W.ZL.1	1					
21.1	15500208000028	高压阀	Liquid valve	1		In Use	GYF-A28N						
21.5	15500213000047	电子膨胀阀组件	Electronic expansion valve subassembly	1		In Use	DPF(T01)1.65C-37(L=900)	1					
23	15500406000012	铜螺母	Copper nut	1	A01=6.35mm(1/4in);B02=9.52mm(3/8in);C03=12.7mm(1/2in);D04=15.9mm(5/8in);E05=19mm(3/4in);F07=22mm(7/8in)	In Use	TLM-C03	0	N	N			

23	15500406000016	铜螺母	Copper nut	1	A01=6.35mm(1/4in);B02=9.52mm(3/8in);C03=12.7mm(1/2in);D04=15.9mm(5/8in);E05=19mm(3/4in);F07=22mm(7/8in)	In Use	TLM-A01	0	N	N			
24	11201011000067	组合传感器	Combination sensor	1		In Use	CGQ-ZH-GW/SW/PQ-L735-XH-P500-3-01	1					
25	12222000002259	端子安装板	Terminal board	1		In Use	BA01.BJ-11	1					
26	17222000A61455	外销变频室外电控盒组件	Electronic control box subassembly	1		In Use	EU-KFR53W/BP3N8-X301(KSN140D21UFZ_RX24Tmini_6MBP20XSF_SDH8654_4204).JD.FW.NXWKB_DK1.1 (AGWL)	1					
26.1	12122000024223	电器安装板	Support of electronic control box	1		In Use	WX101.SL-2	1					
26.2	12122000024222	固定板	Fixing board	1		In Use	WX101.SL-3	1					
26.3	12222000012106	电控安装盒组件	Electronic installing box subassembly	1		In Use	WX101.BJ.6	1					
40	17402001000603	曲轴电加热带	Crankcase electric heating strip	1		In Use	DJRD-358A-800-20W-5	1					
41	17402002000464	电加热管	Electric heating tube	1		In Use	DJRG-150W-030-2	1					
99	17401203012697	压缩机连接线组	Compressor wire subassembly	1		In Use	PXQ-YSJ200RD/190BL/210BK-14#PA66	1					