

# SPECIFICATION

MOTOR	Shaded pole motor
MOTOR TYPE	MOTOR
VOLTAGE (V)	220-240
FREQUENCY (HZ)	50/60
OUTPUT POWER (W)	16
CURRENT (A)	0.5
SPEED (r/min)	1300/1550
ROTATION	CCW(looking towards the shaft)
AIRFLOW DIRECTION	Sucking
MOTOR PROTECTION	Thermally protected
INSULATION CLASS	B
WINDING TEMPERATURE RISE	75K(with load)
PROTECTION CLASS	IP42
OPERATING TYPE	S1
MOUNTING TYPE	Horizontal or Vertical
AMBIENT TEMPERATURE	-30°C+60°C
BEARINGS	sleeve bearings
LUBRICATING OIL	permawick 540
ELECTRICAL CONNECTION	3X0.5mm <sup>2</sup> lead wire 1000mm free length
HI-POT TEST	1800V 1s
APPROVALS	CE
PACKING	12PCS/CTN

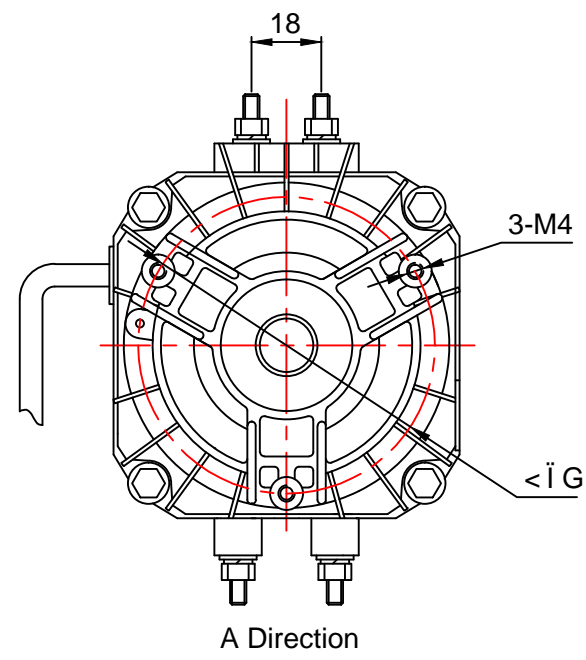
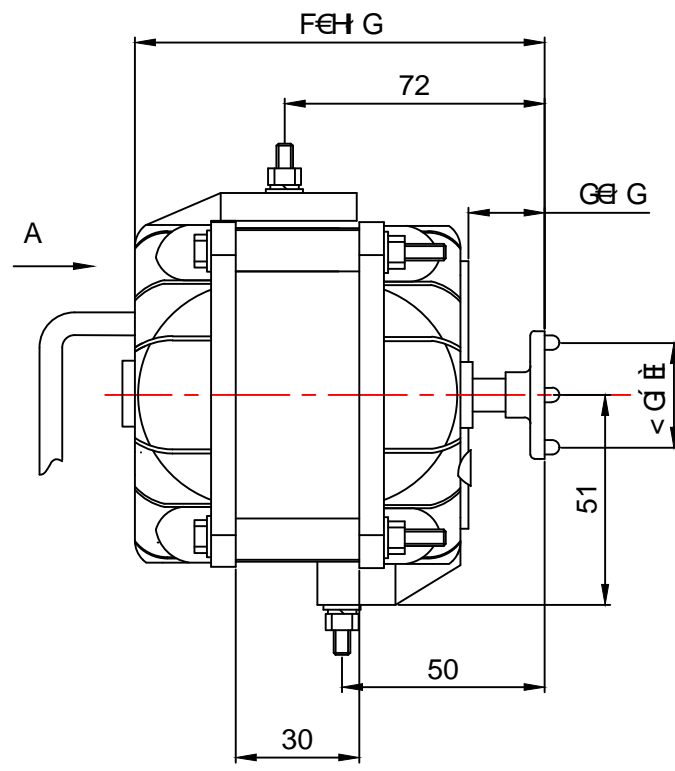
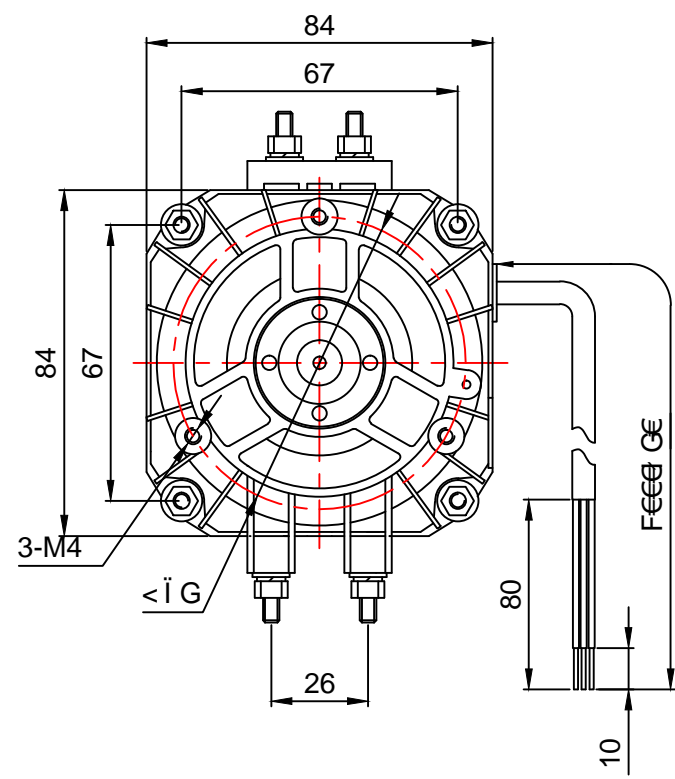

**MTF514RF**  
 220-240V 50/60Hz 16/73W 0.5A **CE**  
 1300/1550rpm CL.B Date: \*\*/\*\*\*\*  
 SKL FAN MOTOR Made in China

MARKER	PLACES	MODIFICATION	FILE NO	SIGNATURE	DATE
DESIGNED		STANDARDIZATION			
DRAWN					
APPROVED					
CARFT		DATE			

PATTERN TAG	QUANTITY	WEIGHT	SCALE
TOTAL PAGES:3	PAGE:2		